

- Jumper 1:  
 1 = 0V GND  
 2 = +12V  
 3 = +12V  
 4 = TL072 PIN 3  
 5 = -12V
- JUMPER 3-4  
 1 = C10  
 2 = C9  
 3 = R11  
 4 = R3

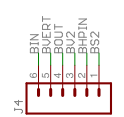
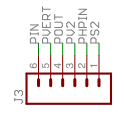
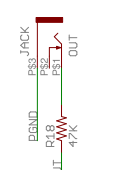
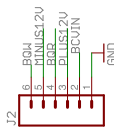
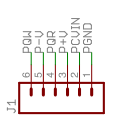
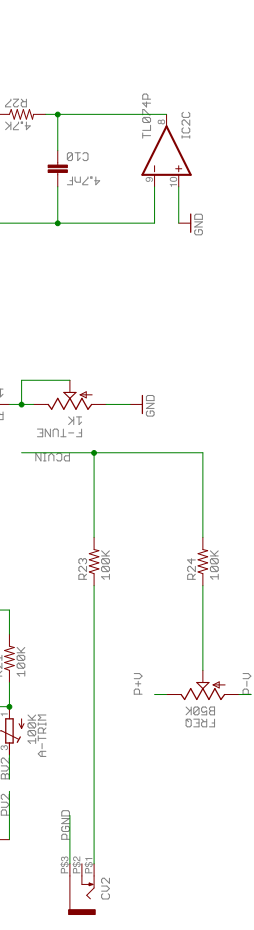
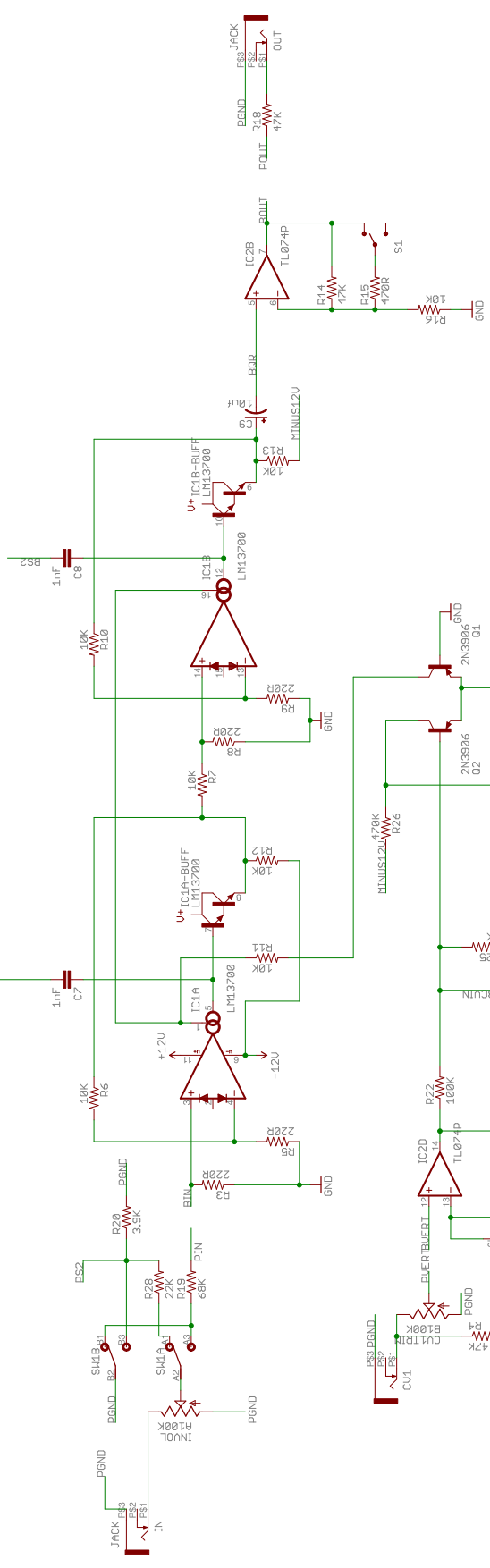
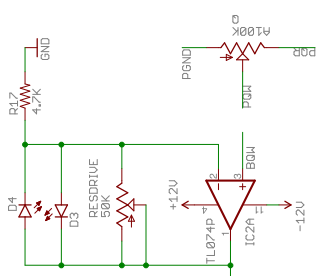
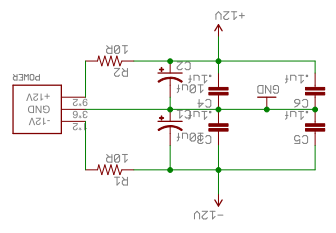

TITLE: AI004 UCF V1  
 Document Number:  
 Date: 2/6/18 8:22 PM

Sheet: 1/1